

# Protect Satellite Systems

Clean Power - Unsafe Power

Clean Data - Unsafe Data

NOTE: AC breaker panel protection is recommended when using data protection. Data protection diverts or dumps excess energy from data lines into the power grounding system. By strategically protecting branch breaker panels with the TTLP, surge events will once again be equalized and safely contained at the breaker panel. This is what protects the ground and the power going to each power outlet.

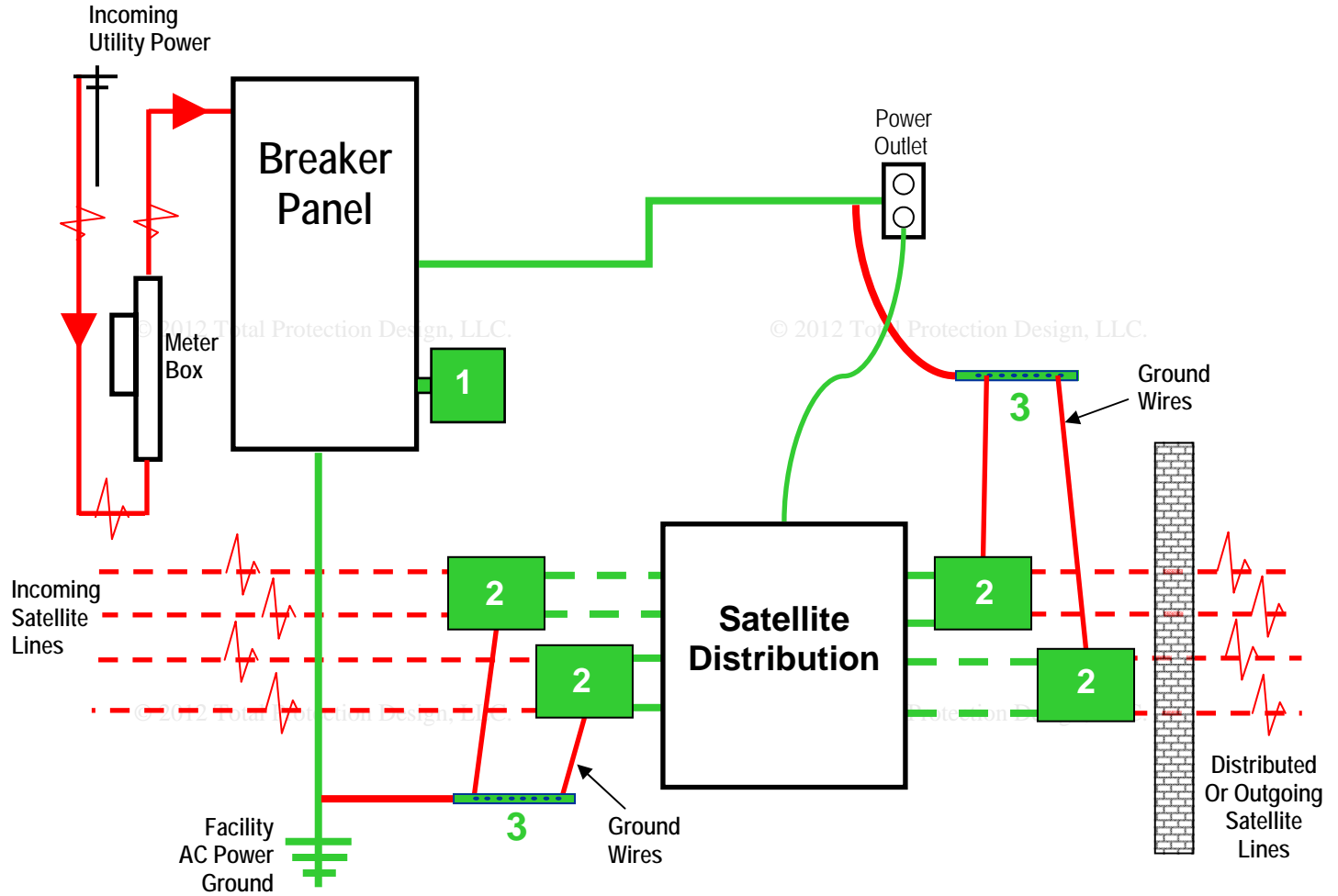

## Total Protection Design

- #1 TK-TTLP-1S240-FL
- #2 TPD-SAT2
- #3 TPD-GRD



Need additional assistance?  
 Call Technical Support  
 1-800-604-9980  
[info@totalprotectiondesign.com](mailto:info@totalprotectiondesign.com)  
[www.TotalProtectionDesign.com](http://www.TotalProtectionDesign.com)

2011 Total Protection Design, LLC. All Rights Reserved. This drawing is the property of Total Protection Design, LLC. The graphics, information and specific ideas in this document are the exclusive property of Total Protection Design, LLC, and must not be made public, copied, or sold. Others seeking permission to reproduce this document, in whole or in part must obtain permission from Total Protection Design in writing.

Notes:  
 Drawings are not to scale and should only be used as a visual representation. Installation instructions should be followed for optimal performance and adequate grounding.

