



Instruction Manual

FS-21

FS-22

Introduction

The iPod® FS-21 and FS-22 are free-standing docking systems that allow an Apple iPod® or iPhone® to become part of a whole-home audio system, and/or be used as a source in a variety of local audio systems. You can place the iPod dock on a desk, table, or other convenient location — allowing quick and easy docking of an iPod — and connect it to both your audio/video system and your computer. By pressing a single button on the iPod, you can change the iPod from the streaming (listening) mode to the music transfer mode, letting you transfer content from your computer to the iPod.

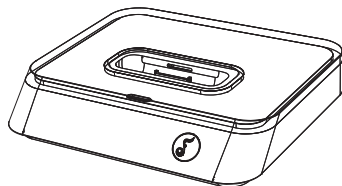

Before installing and using the iPod, please read and follow all of the instructions in this manual carefully.

iPort System Components and Capabilities

This manual covers the FS-21 and FS-22 iPod free-standing systems. The systems have different capabilities and include different components. Except where noted, the connections and installation are the same for both systems.

FS-21 System Capabilities:

- Delivers unbalanced audio from the iPod
- Delivers unbalanced component video, composite video, or S-Video from the iPod
- Allows the iPod to be line-of-sight IR-controlled and remotely IR-controlled (remote IR control requires a compatible 3rd-party controller)
- Allows the iPod's own volume control to control the iPort system volume
- Connects to a computer, allowing the iPod to be updated via iTunes while it is docked*
- Charges the iPod (via the 12V power supply) while it is docked

FS-21 System Box Contents:

- (1) iPod Dock with black color plate
- (1) Audio Cable (3.5mm stereo to 2-RCA, 2 meters)
- (1) Component Video Cable (3.5mm 4-pin to 3-RCA, 2 meters)
- (1) 12V DC Regulated Global Power Supply with USA plug

*Requires USB 2.0 cable, not included

FS-22 System Capabilities:

- Delivers unbalanced audio from the iPod (3.5mm stereo connection)
- Delivers unbalanced component video, composite video, or S-Video from the iPod
- Allows extensive long-distance extended control of iPod functions with 2-way communication (requires compatible 3rd-party controller)
- Allows iPort firmware upgrades (requires optional firmware update cable)
- Allows the iPod to be line-of-sight IR-controlled and remotely IR-controlled (remote IR control requires a compatible 3rd-party controller)
- Allows the iPod's own volume control to control the iPort system volume
- Connects to a computer, allowing the iPod to be updated via iTunes while it is docked*
- Charges the iPod (via the 12V power supply) while it is docked
- Selectable default iPod control mode: General (normal) or Extended (RS-232). See page 10.

iPod Models Supported

The iPort FS-21 and FS-22 can be used with the following iPod/iPhone products via the Dock Adapters included with each:

- iPod classic models (4th generation – 6th generation)



- iPod touch models



- iPod nano models



- iPhone models



FS-22 Box Contents:

- (1) iPort Dock with black color plate
- (1) Audio Cable (3.5mm stereo to 2-RCA, 2 meters)
- (1) Component Video Cable (3.5mm 4-pin to 3-RCA, 2 meters)
- (1) RS-232 Extended Control Cable (RJ11 to female DB9, 2 meters)
- (1) 12V DC Regulated Global Power Supply with USA plug

*Requires USB 2.0 cable, not included

Except where noted, the instructions in this manual apply to all of the above products.

Selecting a Location for the iPort Dock

The iPort FS-21 and FS-22 are designed for use in normal interior environments. When selecting a location for the system, please consider the following:

- Do not use the iPort outside or in a humid or wet environment. The iPort is not waterproof, nor is it water-resistant.
- Avoid placing the iPort dock in direct sunlight as it can interfere with IR operation.

iPort Connections and Controls

Figure 1: iPort Controls and Connections

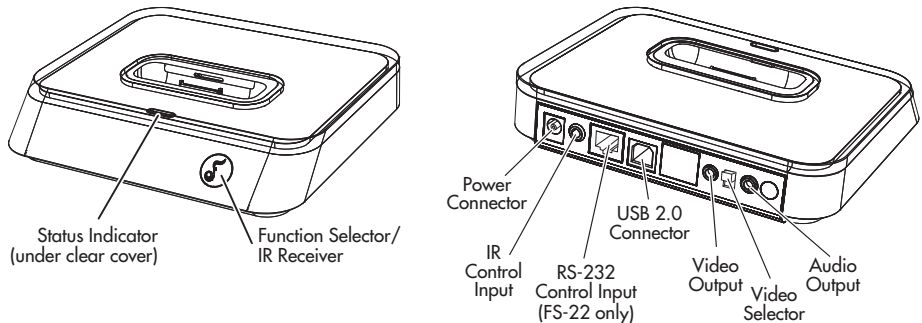

STATUS INDICATOR: Whenever an iPod is docked, the Status Indicator glows *white* and iPort enters the Music Stream (listening) mode.

FUNCTION SELECTOR: Pressing the Function Selector switches the iPort to the Data Transfer mode and the Status Indicator glows *red*. Data can then be transferred from the computer to the iPod. To switch back to the Music Stream mode, eject the iPod from your computer via iTunes. (The iPort will not switch back to the listening mode while data is being transferred from the computer to the iPod.) iPhone and iPod touch models with firmware older than version 2.0 need to be undocked and re-docked to go back into the listening mode.

Note: The iPort does not output audio or video while in the Data Transfer mode.

IR RECEIVER: Receives line-of-sight IR signals from an iPod or iPod remote control (available separately).

POWER CONNECTOR: Connects to the included 12V DC power supply.

IR CONTROL INPUT: 3.5mm mono mini jack connects to a compatible IR control system.

RS-232 CONTROL INPUT (FS-22 ONLY): RJ11 jack connects to a compatible RS-232 control system.

USB 2.0 CONNECTOR: Connects to a computer's USB port via a USB 2.0 cable (USB 1.1 cables will not work).

VIDEO OUTPUT: 3.5mm mini jack connects to a video monitor. The Video Output can send either a component video, composite video, or S-Video signal, depending on what type of cable is plugged into it and the setting of the Video Selector Switch (see below).

VIDEO SELECTOR: When the selector switch is in the DOWN position the Video Output sends component video via the included Component Video Cable. When the selector switch is in the UP position the Video Output sends composite and S-Video via a combination Composite/S-Video Cable (part #70120, not included).

AUDIO OUTPUT: 3.5mm Stereo mini jack connects to an audio system via the included Audio Cable.

There is a switch on the underside of the iPod (see *Figure 2*) that sets the Audio Output to either *Fixed* or *Variable*:

VARIABLE = The iPod system volume is controlled via the iPod's volume control.

FIXED = The iPod's volume control does not control the iPod system volume (recommended in systems where the iPod is being controlled via IR or RS-232).

Figure 2: Fixed/Variable Audio Switch

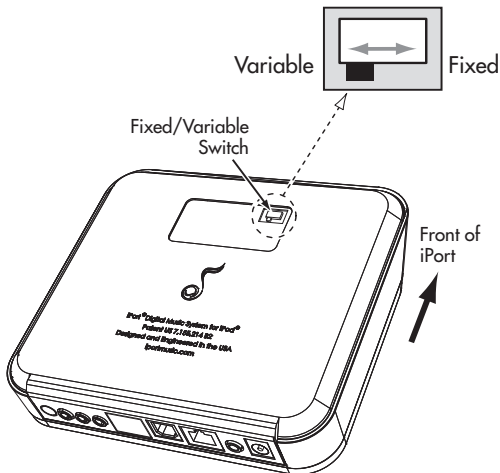

iPort FS-21 and FS-22 System Connections

Figure 3: iPort FS-21 and FS-22 System Connections

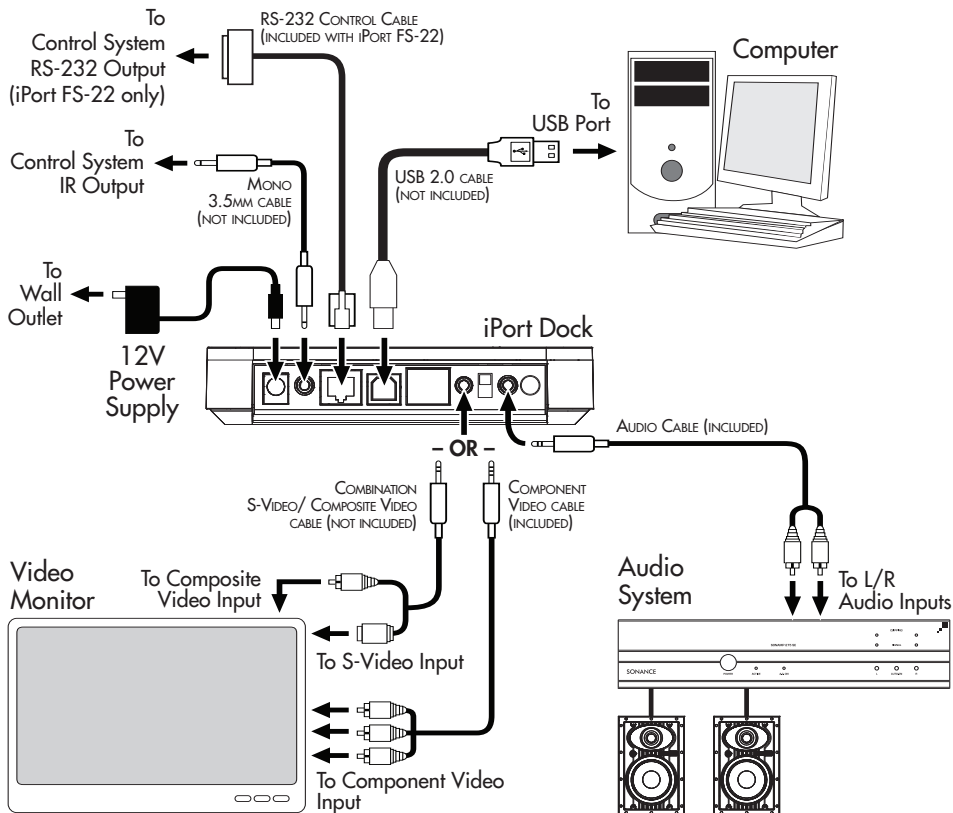

The iPort FS-21 and FS-22 systems' unbalanced audio and video outputs are designed for use in a local-zone system where the audio/video equipment is located less than 25 feet from the iPort. For longer distances, use the iPort Balanced Audio Kit (part #70122, not included) and Balanced Video Kit (part #70123, not included). The Balanced Audio Kit allows the iPort to connect to audio equipment located up to 500 feet away; the Balanced Video Kit allows the iPort to connect to video equipment located up to 250 feet away. For more information about connecting the iPort to a long-distance audio/video system, see the instruction manuals included with the Balanced Audio and Balanced Video kits.

Connecting the iPort to a Local-Zone Audio/Video System

Connect the iPort dock to the computer and audio/video components as shown in *Figure 3*:

1. Connect the included Audio Cable to the iPort's Audio Output and to a source input on the audio system.
2. Connect the iPort's Video Output to an input on the video monitor:
 - If the video monitor has a component video input, set the iPort's Video Selector switch in the DOWN position (see *Video Selector*, on page 5), and connect the included Component Video Cable.
 - If the video monitor does not have a component video input, set the iPort's Video Selector switch in the UP position (see *Video Selector*, on page 5) and use the available combination Composite/S-Video cable (part #70120, not included). If the video monitor has an S-Video input, connect the cable's S-Video plug. If the monitor has a composite video input, connect the cable's RCA plug.
3. Use a USB 2.0 cable (not included) to connect the iPort's USB 2.0 connector to the USB port of the computer containing the iTunes application.
4. Connect a mono 3.5mm-to-3.5mm cable (not included) to the iPort's IR Control Input and to the IR control output of a compatible 3rd-party IR control system.
5. **(iPORT FS-22 ONLY):** Connect the included RS-232 Extended Control Cable to the iPort's RS-232 Control Input and to the RS-232 control output of a compatible 3rd-party RS-232 control system.
Note: For complete information about RS-232 programming and operation go to www.iportmusic.com.
6. Plug the included 12V DC power supply into the iPort's Power Connector.

After confirming that all cables are connected correctly, plug the power supply into a wall outlet.

Docking and Undocking an iPod

Docking

Insert the dock adapter that was included with your iPod all the way into the iPort well (see *Figure 4*). Once inserted, the dock adapter can remain in the well.

Figure 4: Inserting the iPod Dock Adapter

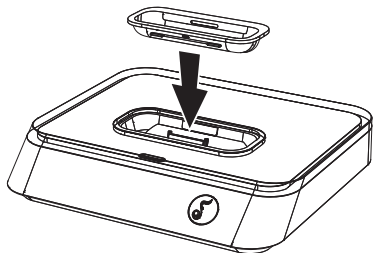
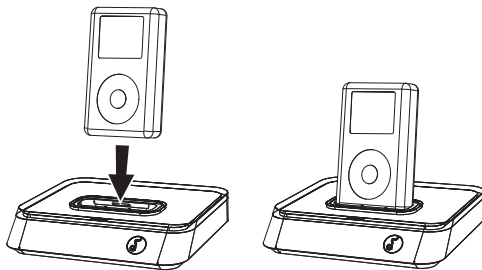

Figure 5: Inserting the iPod



To dock the iPod, gently slide it down into the iPort well, as shown in *Figure 5*. Do not force the iPod down into the well as you may damage the multi-pin connector in the iPort base.

Undocking

Undock the iPod only when the iPort Status Indicator is *white*, indicating that the iPort is in the Music Stream (listening) mode. To undock the iPod while the Status Indicator is *red* (iPort is in the Data Transfer mode), you should eject the iPod from the computer via iTunes. See *Status Indicator and Function Selector* on page 4, for more information.

If you undock the iPod while the Status Indicator is red, Apple computers and PC computers running Windows (other than Windows XP) will display an error message. (Windows XP permits 'hot' connection/disconnection via USB.) When you re-dock the iPod, there will be a slight delay before you can use it while the iPort software re-synchronizes with the iPod. See *Status Indicator and Function Selector* on page 4 for more information.

Controlling the iPod in iPort FS-21 and FS-22 Systems

iPort FS-21 Systems:

- From the iPod front panel.
- By an optional iPort remote (part #70030 — black; part #70032 — white) or iPod remote.
- By IR commands from a compatible IR control system.

iPort FS-22 Systems:

- From the iPod front panel (the *General* control mode).
- By an optional iPort remote (part #70030 — black; part #70032 — white) or iPod remote.
- By IR commands from a compatible IR control system.
- By RS-232 commands from a compatible control system (the *Extended* control mode). Two-way communication from the iPod including iPod metadata — non-program information such as song titles — is available.

NOTE: *The iPort FS-22 is set from the factory to default to the Extended control mode whenever an iPod is docked. To change the default control mode to the General control mode, see page 10.*

IR Control Notes

- iPort IR codes for universal remotes can be downloaded from www.iportmusic.com. At press time supported formats are: RTI, Phillips Pronto style, Logitech/Harmony, and Universal Electronics (UEI). Check www.iportmusic.com for the most up-to-date information.
- Third-generation iPod models only respond to the following IR commands: *Play/Pause*, *Next Track*, and *Previous Track*.

For iPort IR remote control commands, please see the instruction manual accompanying the remote.

Extended (RS-232) Control Notes (FS-22 only)

All iPort FS-22s come from the factory set to default to the *Extended* control mode whenever an iPod is docked. Once an iPod is docked, it can be changed to the General control mode and back to the Extended control mode via commands from the RS-232 controller. To change the default control mode to the *General* control mode:

1. Unplug the iPort 12V power supply from the back of the iPort dock.
2. Remove the iPod dock adapter from the iPod well and then remove the iPort's top cover.
3. Locate the iPod Control Mode Jumper on the iPort circuit board, as shown at the bottom of *Figure 6*. The jumper is set in the Extended position, as shown at the top left of *Figure 6*.
4. Remove the jumper and replace it in the General position, as shown at the top right of *Figure 6*.
5. Replace the iPort's top cover and iPod dock adapter, then plug the iPort 12V power supply back into the iPort dock.

Figure 6: Changing the Default iPod Control Mode

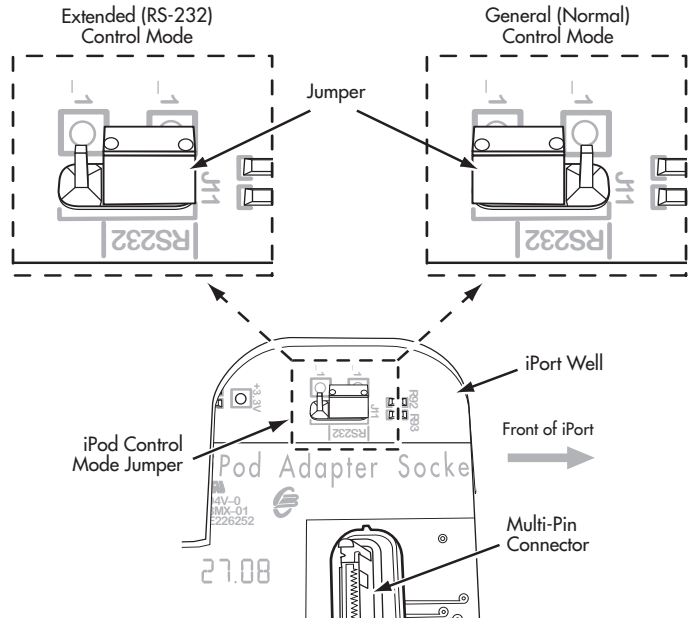

Extended Control Notes (continued)

- When the iPod is in the General control mode it will still respond to an RS-232 command to place it into the Extended control mode.
- When the iPod is set to the Extended control mode, its screen will appear as in *Figure 7*, left. When the iPod is set to the General control mode, its screen will appear as in *Figure 7*, right.
- When the Extended control mode is active, the iPod's front-panel controls will not operate (the iPod interface is disabled).
- When the Extended control mode is active, the iPod will only respond to the following IR control codes: *Play/Pause*, *Next Track*, *Previous Track*, and *Stop*. The iPort dock will also respond to the iPort remote's *LED Brightness Adjust* IR control codes.
- iPhone and iPod touch with firmware older than version 2.0 do not support video in the Extended control mode. The iPhone or iPod touch must be taken out of the Extended control mode and controlled from its front panel. To resume RS-232 control, the iPod must be put back into the Extended control mode via RS-232.
- iPod photo features cannot be controlled in the Extended control mode — the iPod must be put into the General control mode. The photo features can then be controlled from the iPod's front panel controls. To resume RS-232 control, the iPod must be put back into the Extended control mode via RS-232.
- When the Extended control mode is active and if the iPod is placed in the iPort dock while in the *Play* mode, it will automatically enter the *Pause* mode. The installer or programmer can set the RS-232 control system to automatically send a *Play* command to return the iPod to the last playing song when it is inserted in the dock.

For RS-232 commands and programming information, please go to www.iportmusic.com.

Figure 7: iPod Control Screens

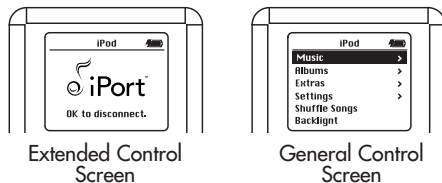

iPhone Control Notes

You can play music and video content stored in an iPhone through the iPort system just as you would play content stored in an iPod. Although you can still use the iPhone's telephone functions while it is docked in the iPort, they do not function through the iPort itself.

- You cannot control the iPhone's telephone or Internet functions via IR while it is docked in the iPort.
- The sound of iPhone telephone calls will not be heard through the iPort system.

NOTE: Although you will hear the iPhone's telephone ringtone through the iPort system, the phone call's audio will not be heard through the iPort system.

When you place the iPhone into the iPort dock, the iPhone screen will display the message shown in *Figure 8*.

- If you select **Yes**, the iPhone will enter "Airplane Mode" and will not receive telephone calls while it is docked in the iPort.
- If you select **No** (or make no selection), the iPhone will still receive phone calls while docked in the iPort.

Figure 8: Message displayed when docking an iPhone in an iPort

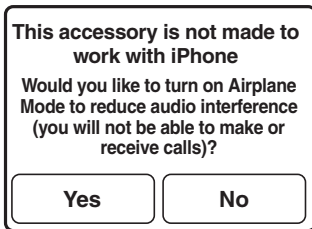

Adjusting the iPort Status Indicator Brightness

Both the white (Music Stream) and red (Data Transfer) indicators can be set to one of 3 illumination levels: *BRIGHT*, *MEDIUM*, and *DIM*. The white (Music Stream) indicator can also be set to *OFF*. These settings can be changed via RS-232 commands or by an optional iPort remote.

Specifications

Power supply output: 12V DC, 1 Amp

Power supply input: 110 ~ 240 VAC 50 ~ 60Hz, 0.45 Amps

In Case of Difficulty

If your iPort does not seem to be working properly, before calling iPort or returning the unit to the store, please read through the following section. You may be able to correct the problem yourself with a minimum of inconvenience. If, after trying all of the applicable solutions, your iPort still seems not to be working properly, call your dealer or call us at 888 45-IPORT.

Section	Problem	Solution
Power	iPort status indicator is not lit when an iPod is docked into an iPort.	1) Ensure that the power supply is plugged into an AC power outlet and that the DC plug is securely plugged into the power connector on the iPort dock
		2) Ensure that the iPod is fully seated into the iPort.
Status Indicator	iPort status indicator turns off immediately after docking an iPod.	1) Check to see if iPod is starting up (Apple logo on iPod display). The status indicator will illuminate once the iPod has completed start up.
	Status indicator flashes when trying to activate data transfer mode.	1) Ensure that the USB connector is securely connected to the computer and to the iPort.
	Status indicator remains RED after being disconnected from computer.	1) If using an iPod touch or iPhone, physically remove it from the dock. After a few moments the iPod menu will appear on its display. Re-dock to stream music. 2) Pressing and holding the iPort Function Selector for five seconds will reset the iPort, changing the status indicator back to WHITE.

continued on page 14

In Case of Difficulty (continued)

Section	Problem	Solution
Audio	No audio is produced although the iPod shows it is playing.	<ol style="list-style-type: none">1) Ensure that the audio output connections from the iPort to the amplifier are securely connected.2) Ensure that the iPod is fully seated into the iPort.
RS-232	Cannot control the iPod in 2-way mode.	<ol style="list-style-type: none">1) Ensure that the RJ-11 to DB-9 cable is securely connected to both the iPort and to the control system being used.]2) When the iPod is in Extended control mode, the iPod's front-panel controls will not operate (the iPod interface is disabled).
	iPod does not respond to IR commands when in 2-way mode.	<ol style="list-style-type: none">1) When 2-way mode is active, the iPod will only respond to the following IR control codes: <i>Play/Pause</i>, <i>Next Track</i>, <i>Previous Track</i>, and <i>Stop</i>.
Video	No video is displayed on the video monitor although the iPod shows it is playing video.	<ol style="list-style-type: none">1) Ensure that the video output connection from the iPort to the video monitor is secure.2) Ensure that the iPod is fully docked into the iPort.3) Undock the iPod and re-dock it in the iPort.

©2008 Dana Innovations. All rights reserved.

iPort is a trademark of Dana Innovations. Apple, iPod, iTunes, and iPhone are trademarks of Apple Inc.

Due to continuous product improvement, all specifications are subject to change without notice.

Apple is not responsible for the operation of this device or its compliance with safety and regulatory standards.

For the latest iPort product information go to www.iportmusic.com

LIMITED ONE (1) YEAR WARRANTY

iPort warrants to the first end-user purchaser that this iPort-brand product (“Product”), when purchased from and installed by an authorized iPort Dealer/Distributor, will be free from defective workmanship and materials in the initial installation for the period stated below. iPort will at its option and expense during the warranty period, either repair the defect or replace the Product with a new or remanufactured Product or a reasonable equivalent at no charge for parts, labor and return shipping.

EXCLUSIONS

TO THE EXTENT PERMITTED BY LAW, THE WARRANTY SET FORTH ABOVE IS IN LIEU OF, AND EXCLUSIVE OF, ALL OTHER WARRANTIES, EXPRESS OR IMPLIED, AND IS THE SOLE AND EXCLUSIVE WARRANTY PROVIDED BY IPORT. ALL OTHER EXPRESS AND IMPLIED WARRANTIES, INCLUDING THE IMPLIED WARRANTY OF MERCHANTABILITY, IMPLIED WARRANTY OF FITNESS FOR USE, AND IMPLIED WARRANTY OF FITNESS FOR A PARTICULAR PURPOSE ARE SPECIFICALLY EXCLUDED. No one is authorized to make or modify any warranties on behalf of iPort.

The warranty stated above is the sole and exclusive remedy and iPort’s performance shall constitute full and final satisfaction of all obligations, liabilities and claims with respect to the Product. IN ANY EVENT, IPORT SHALL NOT BE LIABLE FOR CONSEQUENTIAL, INCIDENTAL, ECONOMIC, PROPERTY, BODILY INJURY, OR PERSONAL INJURY DAMAGES ARISING FROM THE PRODUCT, ANY BREACH OF THIS WARRANTY OR OTHERWISE.

This warranty statement gives you specific legal rights, and you may have other rights which vary from state to state. Some states do not allow the exclusion of implied warranties or limitations of remedies, so the above exclusions and limitations may not apply. If your state does not allow disclaimer of implied warranties, the duration of such implied warranties is limited to the period of iPort’s express warranty.

Your Product Model and Description: iPort FS-21, FS-22

Warranty Period for this Product: One (1) year from the date on the original sales receipt, invoice or other satisfactory proof of purchase.

continued on back cover

Additional limitations and Exclusions From Warranty Coverage: The warranty described above is non-transferrable, and does not include damage to allied or associated equipment which may result for any reason from use with this Product, and does not include Product failure caused by accident, disaster, negligence, improper installation, misuse (e.g. overdriving the amplifier or speaker, excessive heat or cold or humidity, outdoor installation), or from service or repair which has not been authorized by iPort.

Obtaining Authorized Service: If you purchased your iPort from an iPort Dealer, you (1) must contact your authorized iPort Dealer/Installer or call iPort Customer Service at (800) 582-0772 within the warranty period, (2) must obtain a return merchandise number (RMA), and (3) deliver the Product to iPort shipping prepaid during the warranty period, together with the original sales receipt, invoice or other satisfactory proof of purchase from your iPort Dealer. If you did not purchase from an iPort dealer, you must contact your authorized seller within the warranty period and obtain instructions for obtaining authorized service.

